

ASSEMBLY ACCORDING TO THE FOLLOWING GUIDELINES IS THE BASIS FOR WARRANTY SERVICE ENTITLEMENT.

THE ASSEMBLY AND ACCEPTANCE GUIDE OF PVC, ALUMINIUM AND WOODEN WOODWORK

THE GUIDE INCLUDES TECHNICAL CONDITIONS OF ASSEMBLY EXECUTION AND ACCEPTANCE REGARDING BUILT-IN WINDOWS AND DOORS IN RESIDENTIAL AND PUBLIC BUILDINGS. THE GUIDE IS INTENDED FOR ASSEMBLY COMPANIES, DESIGNERS, END USERS, BUILDING INSPECTION, INDIVIDUAL CLIENTS.

WOODWORK FUNCTIONS

- separating the interior of the building from outdoor weather conditions,
- ensuring thermal and acoustic insulation,
- tightness of window and door opening, ,
- carrying the load on the windows and doors into the walls of the building,
- ensuring operational safety
- visual contact with the external environment, living comfort, light, ability to communicate.

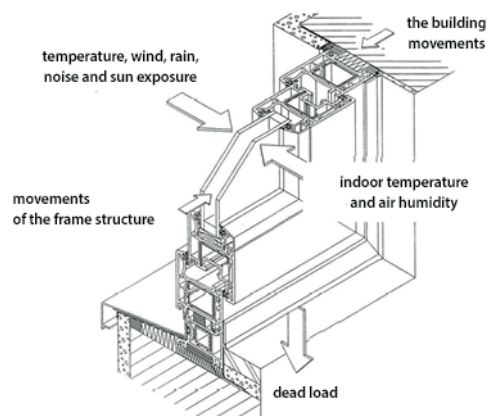

THE RULES OF WINDOW AND DOOR WOODWORK SELECTION AND ASSEMBLY.

1. The size, dimensions and structure must comply with the construction project, or follow the measurements and proper strength calculations of the woodwork.
2. Before the woodwork specification with the façade, the following has to be checked:
 - the necessity to use reinforcing elements, due to the size, breadth and static workload of the woodwork, such as – static connectors, poles [between the façade elements, screwed on the façade elements],
 - the necessity to apply sealing elements of the frames,
 - the necessity to provide for compensation for stress, the necessity to apply expansion elements,
 - if the applied external shutters may cause woodwork deformation – the sash frame, if it will not constitute excessive load for the construction, if it is necessary to install the shutters independently that will not load the woodwork,
 - if the structures in the facade/ loaded with shutters/ will open easily.
3. Supporting and spacer chocks are applied to distance and fit the woodwork in the reveals. The chocks should be placed in order to ensure the stress compensation of the frames in changeable temperatures. The woodwork installation when using only mechanical connectors – dowels, bolts or anchors, without the application of supporting and spacer chocks, is not enough to carry the load. With time, the woodwork may deform.
4. Supporting chocks, which should not be removed, ought to be made of impregnated hard wood or of hard PVC.

5. Chocks that determine the position of the frames in the hole should be removed after the fitting, whereas the supporting chocks must not be removed.
6. The acceptable vertical and horizontal variations in woodwork positioning in a hole with the length of the element up to 3.0m, should not exceed 3.0mm.

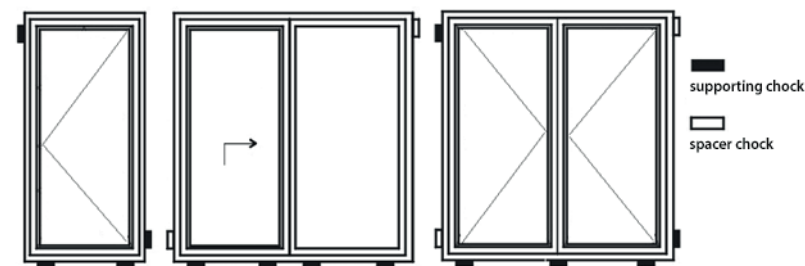

Fig. 1 The position of spacer chocks to determine the woodwork position.

7. The gaps should not be smaller than 10mm, and the maximum size should not exceed 20-30mm. The contacts of frames elements and the facade elements should be made as butt joints and sealed. If the breadth is bigger, or the woodwork is dark, one should apply the proper settlement joints, also sealed.
8. Vapor-barrier and vapor-permeable tapes, elastic vapor-barrier and vapor-permeable foils, foil butyl tape for internal sealing must be applied following the producers' recommendations.
9. Fixing the woodwork on the reveals/ façades.



Fig. 2 Dimensioning the reveal in the wall: with and without the jamb.

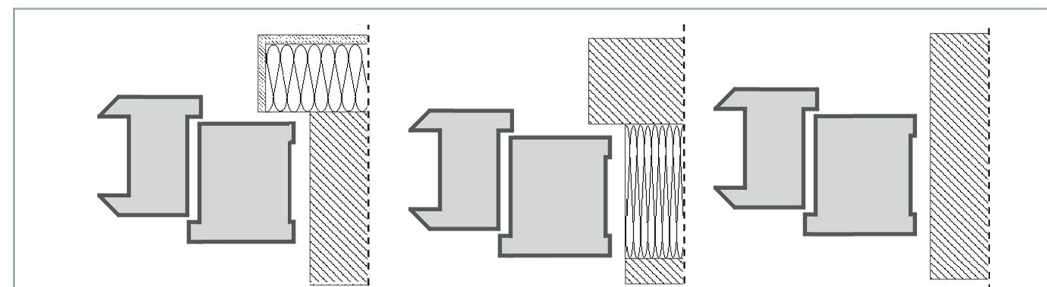
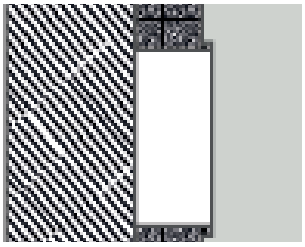
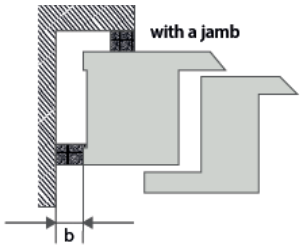

Fig. 3 Positioning of the frame in the reveals of walls of different structure: in a full single-layer wall, in a multi-layer wall with internal insulation [with a jamb], in a full wall with external insulation [with a jamb].

Assembly according to the following guidelines is the basis for warranty service entitlement.

Minimum gaps				
Types of sections	Reveals without the jamb		Reveals with the jamb	
				
The length of the elements (m)				
Type of the profiles	Up to 1,5	Up to 2,5	Up to 3,5	Up to 4,5
	The minimal width of the gap - b (mm)			
White PVC	10	15	20	25
PVC with a veneer, dyed in the mass	15	20	25	30
PVC with a veneer	10	10	15	20
Aluminum with a thermal divider (light)	10	10	15	20
Aluminum with a thermal divider (dark)	10	15	20	25
Wooden	10	10	10	10

The sealing material should be characterized by 25% formability

The elements which fix the woodwork in the reveals/ facades

- The fixing should be performed making sure that the external load is carried into the building structure/ facade through connectors, and the woodwork functionality should be perfectly preserved; i.e. the movement of the sash when opening and closing the window, should be fluid, free and without bumping against other construction elements. Similar rules should be followed when installing the woodwork in facades.
- The fixings should be distributed on the sides of the woodwork frame with spacing not bigger than - from the corners 15-20 cm, between the fixings 50-70 cm. The lower frame should be also fixed.

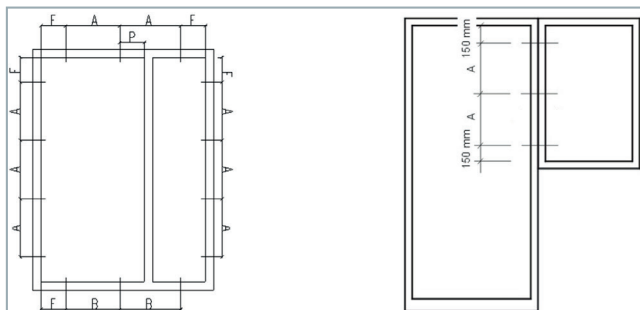

Fig. 5 Distribution of dowelling points.

- Assembly connectors (dowels, anchors and bolts/screws) are applied to fix the frames in the building walls/facades - depending on the type of the wall (monolithic, layered) and on the method of fixing. The hollow of the elements in the wall should be precisely selected.
- Polyurethane foams and insulation materials are not meant for fixing,

but solely for sealing and insulating the reveal between the frame and the wall.

- Dowels are applied for concrete, wall of full brick, of silicate brick, hollow brick, ceramic and cement hollow bricks, gas concrete, stone etc.
- Screws may be used to fix the frame to the concrete, full brick, silicate brick, hollow brick, light concrete, wood etc. The choice of screws must depend on the type of frame. Screws may be used to connect the frame with the façade elements.
- Building anchors should be applied whenever the distance of the frame is too big to apply dowels, e.g. in lower (threshold) fixing in layer walls solutions etc.
- External shutters should be fixed to lintels, or to the proper bolts, transom bars.
- The fixing should end with signature of certificate of acceptance.

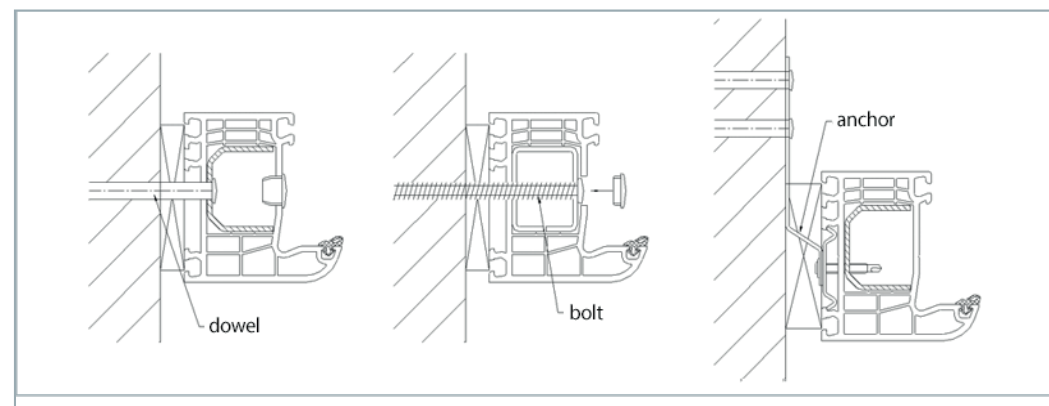

Fig. 6 Types of mechanic connectors.

Attention: in case of aluminum joinery made of sections with thermal dividers, the above-mentioned connectors are fixed to the internal chamber of the section, or in the axis of the integrated profile, using a metal pad that protects against the carrying of the load into thermal pads made of plastic.

Assembly according to the following guidelines is the basis for warranty service entitlement.

THE RULES OF THE THREE-LAYER SEALING SYSTEM.

Internal sealing between the frame and the reveal should not allow vapor permeability from the room into the gap between the window and the wall, i.e. it should prevent vapor condensation in the gap between the frame and the reveal (i.e. in the spots of temperature higher than the dew point).

The ground rule of sealing the window/wall connector is 'tighter on the inside than on the outside'. It permits vapor diffusion from the connector.

Central layer (thermal insulation) The gap between the frame and the reveal should be fully filled with a layer of thermal insulation. During the sealing, one must make sure the gap is entirely filled and the frames are not deformed.

External sealing between the frame and the reveal should be made to prevent rainwater from passing into the gap between the frame and the wall, and, at that

same time, vapor-permeability must be maintained.

Sealing materials The following materials, depending on the spot of application, may be used to do the sealing: the polyurethane foam, tapes and porous sponges, mineral wool, glass fiber etc. vapor-barrier and vapor-permeable foil, impregnated expandable tapes, foil butyl tape, permanently elastic sealant (neutral silicon), construction spacer lines, compressible sealing materials.

Application rule The seal application must comply with

the manufacturer's guidelines, regarding:

- chemical compatibility of contacting materials,
- cleaning the contact surface,
- priming the contact Surface (depending on the material type),
- requirements regarding the application depending on the humidity and air temperature